









SPIRO - ROHRE UND FORMSTÜCKE

Ausführung in „SAFE“

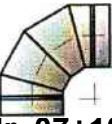

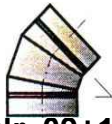
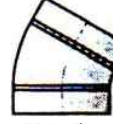
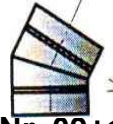
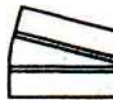



Grösse (mm)	Rohr / m	Muffe	VBR	Bogen 90°	Bogen 45°	Bogen 30°	Bogen 15°
	 Nr. 01	 Nr. 05	 Nr. 06	  Nr. 07+10	  Nr. 09+12	  Nr. 09+13	  Nr. 09+13
80	7.50	6.95	3.45	15.15	13.35	12.60	14.25
100	9.60	7.45	3.90	15.15	13.35	12.60	14.25
125	11.60	7.55	4.40	18.80	14.90	13.85	17.15
140	Auf Anfrage	—	—	—	—	—	—
150	14.50	7.65	4.75	24.80	19.45	18.50	18.50
160	15.00	7.75	4.85	25.00	20.15	18.30	19.50
180	17.20	9.05	5.25	33.90	23.95	22.80	25.20
200	19.30	10.30	5.45	37.70	27.10	25.20	27.70
224	20.00	11.45	6.10	45.25	35.80	29.80	34.35
250	21.50	12.15	6.40	51.05	37.90	33.05	36.85
280	23.50	13.85	6.80	57.65	45.35	38.20	37.90
300	26.80	14.45	7.25	63.10	47.05	40.40	40.20
315	30.00	15.35	8.10	68.25	53.00	45.50	46.50
355	40.20	16.80	9.35	72.75	60.70	51.00	50.60
400	43.80	24.05	21.00	85.45	67.70	56.10	55.95
450	49.20	26.55	23.65	160.00	120.00	120.00	120.00
500	53.40	29.50	26.25	190.00	128.00	128.00	128.00

SPIRO - ROHRE UND FORMSTÜCKE

Ausführung in „SAFE“



Grösse (mm)	Schalungsknie ohne „SAFE“	Schalungsknie „SAFE“	Schalungsbogen kurz	Manchetten
			 Ohne Stützen !!	
80	—	56.00	20.70	15.10
100	—	52.00	21.30	15.90
125	—	54.00	23.75	17.10
140	—	58.00	Gibt es nicht	17.70
150	—	61.00	28.25	18.60
160	—	70.00	28.75	19.65
180	—	75.00	Gibt es nicht	21.15
200	—	75.00	34.65	22.15
224	—	78.00	—	22.90
250	—	81.00	—	24.00
280	—	85.00	—	24.95
300	—	96.50	—	27.10
315	—	112.50	—	31.10
355	—	—	—	35.75
400	—	—	—	42.55
450	—	—	—	—
500	—	—	—	—

SPIRO - ROHRE UND FORMSTÜCKE

Ausführung in „SAFE“



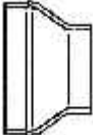
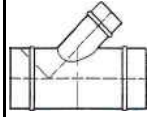

Grösse (mm)	Reduktion gepr.	Reduktion	Red.exc	T-Stk. 90°	T-Stk. 90° red.	T-Stk. 45°	T-Stk. 45° red.
	RCD  Nr. 18	RC  Nr. 19	RE  Nr. 20	TCD  Nr. 21	TCR  Nr. 23	TO  Nr. 25	TOR  Nr. 27
80	—	—	—	46.20	—	68.00	—
100	15.25	—	35.00	52.90	Auf anfrage	73.50	Auf anfrage
125	16.70	—	38.00	55.15	Auf anfrage	77.00	Auf anfrage
140	—	—	—	—	—	—	—
150	17.65	—	42.50	56.00	Auf anfrage	82.50	Auf anfrage
160	18.10	—	47.00	56.90	Auf anfrage	83.50	Auf anfrage
180	18.90	—	48.50	59.95	Auf anfrage	91.50	Auf anfrage
200	20.80	—	55.50	66.80	Auf anfrage	102.50	Auf anfrage
224	—	50.00	60.00	72.05	Auf anfrage	132.00	Auf anfrage
250	27.10	55.00	65.00	78.45	Auf anfrage	142.00	Auf anfrage
280	—	61.00	85.00	86.60	Auf anfrage	155.00	Auf anfrage
300	—	68.00	88.00	92.40	Auf anfrage	169.00	Auf anfrage
315	—	85.00	100.00	98.70	Auf anfrage	181.50	Auf anfrage
355	—	105.00	125.00	107.80	Auf anfrage	203.50	Auf anfrage
400	—	118.00	145.00	170.00	Auf anfrage	220.00	Auf anfrage
450	—	125.00	172.00	195.00	Auf anfrage	—	—
500	—	145.00	190.00	240.00	Auf anfrage	—	—

SPIRO - ROHRE UND FORMSTÜCKE

Ausführung in „SAFE“

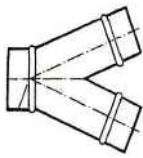
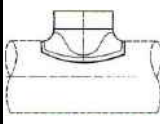
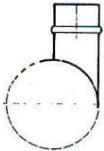
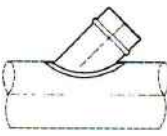

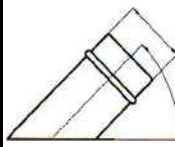
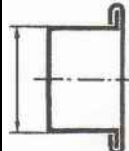
Grösse (mm)	Gabelstk. 2x45°	Sattelst.	Sattelst.exc.	Sattelst. 45°	Stutzen E.B.	Stutzen 45°	Deckel
							
	Nr. 30	Nr. 35	Nr. 37	Nr. 38	Nr. 41	Nr. 43	Nr. 45
80	Auf anfrage	9.75	23.10	23.10	5.35	29.80	9.90
100	Auf anfrage	10.40	23.30	23.30	5.50	25.10	10.30
125	Auf anfrage	11.80	26.10	26.10	5.60	27.30	11.25
140	Auf anfrage	—	—	—	—	—	—
150	Auf anfrage	13.75	32.00	32.00	7.00	32.60	12.20
160	Auf anfrage	14.00	34.00	34.00	7.10	32.80	13.75
180	Auf anfrage	16.20	43.00	43.00	8.95	36.00	15.20
200	Auf anfrage	18.10	46.00	46.00	9.05	37.20	16.50
224	Auf anfrage	70.00	76.00	76.00	10.30	40.00	19.50
250	Auf anfrage	76.50	83.00	83.00	10.80	43.90	20.15
280	Auf anfrage	82.50	88.50	88.50	16.05	49.70	27.10
300	Auf anfrage	88.50	94.50	94.50	16.50	51.20	29.50
315	Auf anfrage	93.50	99.00	99.00	17.95	53.50	31.10
355	Auf anfrage	98.50	105.50	105.50	20.20	56.40	33.10
400	Auf anfrage	104.50	112.00	112.00	21.95	59.40	35.70
450	Auf anfrage	-	-	-	25.10	71.70	83.50
500	Auf anfrage	-	-	-	31.50	82.50	95.50

SPIRO - ROHRE UND FORMSTÜCKE

Ausführung in „SAFE“





Grösse (mm)	Maschen-gitter	Maschengit-ter 45°	Einstellklap-pen	Motor-Einstellklap-pen	Stutzen 45°
	 Nr. 47	 Nr. 48	 Nr. 49	 Nr. 52	 Nr. 43
80	30.65	68.00	32.55	70.80	Fr. 29.90
100	31.40	70.00	39.20	74.60	Fr. 25.20
125	34.05	76.00	40.45	75.20	Fr. 27.30
140	—	—	—	—	—
150	38.00	85.00	42.85	76.40	Fr. 32.60
160	39.90	89.00	43.40	76.50	Fr. 33.30
180	45.50	98.00	44.55	77.00	Fr. 36.10
200	48.30	106.00	44.95	78.00	Fr. 37.20
224	51.55	112.00	45.90	80.30	-
250	53.25	118.00	51.85	84.50	-
280	63.75	125.00	77.50	89.60	-
300	65.55	130.00	84.00	103.20	-
315	68.25	139.00	94.50	104.00	-
355	71.95	145.00	110.00	118.00	-
400	76.75	164.00	132.00	145.50	-
450	Auf anfrage	Auf anfrage	160.00	168.40	-
500	Auf anfrage	Auf anfrage	180.00	190.00	-

SPIRO - ROHRE und Formstücke

Ausführung in „SAFE“



Grösse (mm)	Rohrschalldämpfer 25 mm	Rohrschalldämpfer 50 mm	Dopo-Phon Typ 1
			
	Nr. 57 Länge 1000 mm	Nr. 58 Länge 1000 mm	Nr. 60
80	Auf anfrage	126.80	-
100	Auf anfrage	141.55	146.20
125	Auf anfrage	168.20	147.80
140	Auf anfrage	188.85	162.80
150	Auf anfrage	190.40	163.20
160	Auf anfrage	195.60	167.80
180	Auf anfrage	210.50	173.90
200	Auf anfrage	216.95	181.30
224	Auf anfrage	223.85	197.60
250	Auf anfrage	255.95	231.50
280	Auf anfrage	Auf anfrage	244.10
300	Auf anfrage	297.25	-
315	Auf anfrage	317.50	-
355	Auf anfrage	334.55	-
400	Auf anfrage	Auf anfrage	-
450	Auf anfrage	Auf anfrage	-
500	Auf anfrage	Auf anfrage	-

Rohrschalldämpfer Schalldämmwerte



Rohr-Schalldämpfer Isolation 25 / 50mm

		Oktav - Mittenfrequenz [Hz] / <i>Fréquence moyenne en octave [Hz]</i>													
		125		250		500		1000		2000		4000		8000	
ø d [mm]	Isol. [mm]	25	50	25	50	25	50	25	50	25	50	25	50	25	50
	80		7.5	11.0	12.0	20.0	25.0	38.0	44.0	48.0	41.0	52.0	29.0	36.0	18.0
100		6.0	10.0	11.7	19.0	24.7	37.0	42.3	48.0	40.5	50.0	28.6	35.0	17.2	29.0
160		4.5	8.0	7.8	13.0	14.8	28.0	31.4	42.0	40.0	39.0	15.9	24.0	8.1	20.0
200		4.0	7.0	8.8	11.0	12.5	23.0	29.7	32.0	32.6	30.0	15.3	20.0	6.9	16.0
250		3.0	5.0	6.2	9.0	11.4	19.0	22.5	30.0	20.8	28.0	10.3	15.0	5.5	13.0
300		3.5	4.0	4.5	9.0	9.7	15.0	20.6	26.0	20.5	19.0	8.7	13.0	4.3	11.0
355		3.0	4.0	5.3	6.0	7.8	13.0	14.8	21.0	17.6	16.0	8.1	9.0	5.1	8.0
400		2.0	3.0	4.7	5.0	8.4	11.0	17.7	18.0	10.9	14.0	3.7	8.0	1.7	7.0
500		1.0	3.0	3.7	4.0	6.8	9.0	17.6	15.0	10.0	12.0	4.5	5.5	3.1	6.0

KASTENSCHALLDÄMPFER

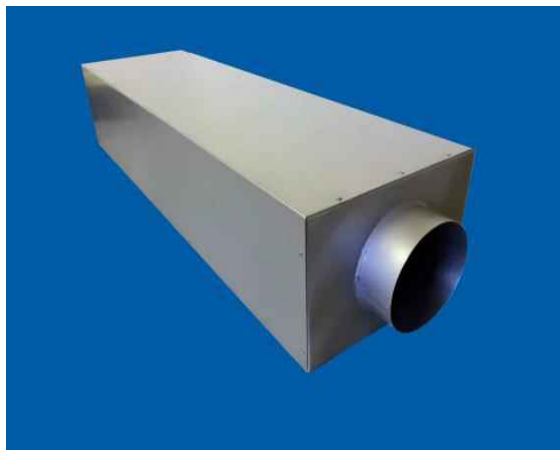

PREISLISTE

Alle Masse in mm

Breite	Höhe	Länge	Anschlüsse	Preis
200	160	900	125	105.-
260	180	900	150	112.-
260	190	900	160	115.-
200	160	800	125	100.-
260	180	800	150	105.-
260	190	800	160	110.-
200	160	700	125	95.-
260	180	700	150	100.-
260	190	700	160	105.-

Auch sämtliche anderen üblichen Grössen lieferbar!!

DÜNNWANDISOLIERUNG ROS

Für Wickelfalzrohre



**ROBUST,
mit hochreissfestem Gewebe**

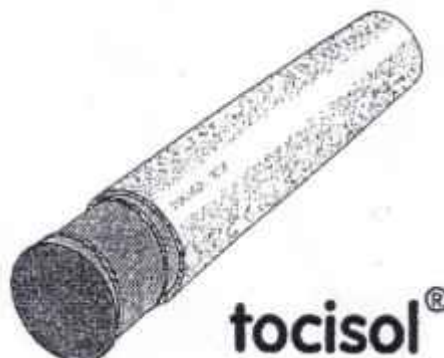

Ø mm	Länge m	 m	Preis m
80	10	60	4.40
100	10	40	6.00
125	10	30	7.50
150	10	20	8.50
160	10	20	9.00

Die neue, robuste Dünwandisolierung ist aus vernetztem, geschlossenzelligen PE-Schaum, FCKW-frei, mit hochreissfestem Gewebe ummantelt und einer PE-Folien-Innenkaschierung für das optimale gleiten am Rohr. Isolierung gegen Schwitzwasser und Körperschall.

Material: Aus vernetztem, geschlossenzelligem und FCKW-freiem Polyethylenschaumstoff
Isolierstärke: 4 mm
Brandklasse: B2 Oe Norm B 3800

SILPHON - SCHALLDÄMPFERKULISSE



Aus Melaminharzschaumstoff Si 2304



Vorteile:

- Sehr gute Schallabsorptionswerte.
- Mineralfaserfrei - physiologisch unbedenklich.
- Hohe chemische Beständigkeit gegen Kohlenwasserstoffe und Alkohole (DIN53428 und 535723).
- Hohe Gebrauchstemperaturbeständigkeit.
- Einfache,saubere Verarbeitung und Montage.
- Geringes Gewicht.
- Unterschiedlichste Ausstattungsoptionen zur Anpassung an den individuellen Bedarf.
- Löst Schallprobleme, da jederzeit nachrüstbar.

Lieferformen:

- In Längen a 1200 mm oder nach Wunsch.

PREISLISTE

SR - Phon



Durchmesser	Länge = 600mm	Fr. / Stück
80	SR-PH080/60	19.70
100	SR-PH100/60	21.80
125	SR-PH125/60	24.80
150	SR-PH150/60	30.00
160	SR-PH160/60	37.20
180	SR-PH180/60	42.30
200	SR-PH200/60	49.70
225	SR-PH225/60	60.80
250	SR-PH250/60	69.00
280	SR-PH280/60	74.20
315	SR-PH315/60	87.40
355	SR-PH355/60	151.20
400	SR-PH400/60	195.60
450	SR-PH450/60	223.20
500	SR-PH500/60	289.50

Durchmesser	Länge = 12000mm	Fr. / Stück
80	SR-PH080/120	27.50
100	SR-PH100/120	29.70
125	SR-PH125/120	32.70
150	SR-PH150/120	41.80
160	SR-PH160/120	55.00
180	SR-PH180/120	64.20
200	SR-PH200/120	83.70
225	SR-PH225/120	96.90
250	SR-PH250/120	118.30
280	SR-PH280/120	130.50
315	SR-PH315/120	141.80
355	SR-PH355/120	235.20
400	SR-PH400/120	300.00
450	SR-PH450/120	344.80

SILPHON

Schalldämpferkulisse - Daten



Material:

- Silphon 2304 besteht aus einem duroplastischen, elastifizierten Schaumstoff auf der Rohstoffbasis Melaminharz.
- Schaumfarbe weiss.
- Oberfläche luftdurchlässig geprägt und leicht verdichtet.

Eigenschaften:

- Brandverhalten BKZ 5.3
- DIN 4102
- S4,SR2,ST2 DIN 54 837

Temperaturbeständigkeit:

- -40° bis +150° C (Langzeit-Gebrauchstemperatur) kurzfristig bis +200° C Wärmeleitfähigkeit.
- $\lambda = 0,035 \text{ W/mK}$ (DIN 52612).

Diagramm mit und ohne Silphon Schalldämpferkulissen.

Druckverlustdiagramm

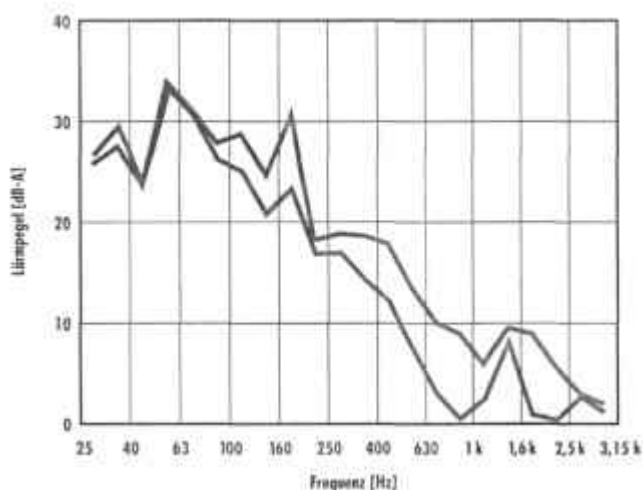

Mit Silphon-Schalldämpfer:
Mittelwert = 18 dB-A

Ohne Silphon-Schalldämpfer:
Mittelwert = 23 dB-A

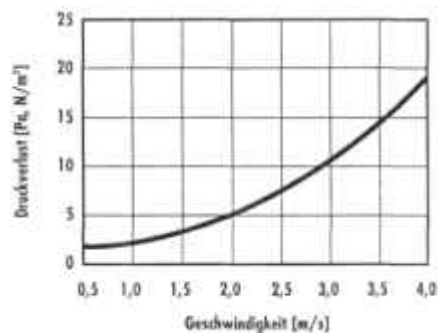

REGENHUT

Typ: AR



Preise nur auf Anfrage

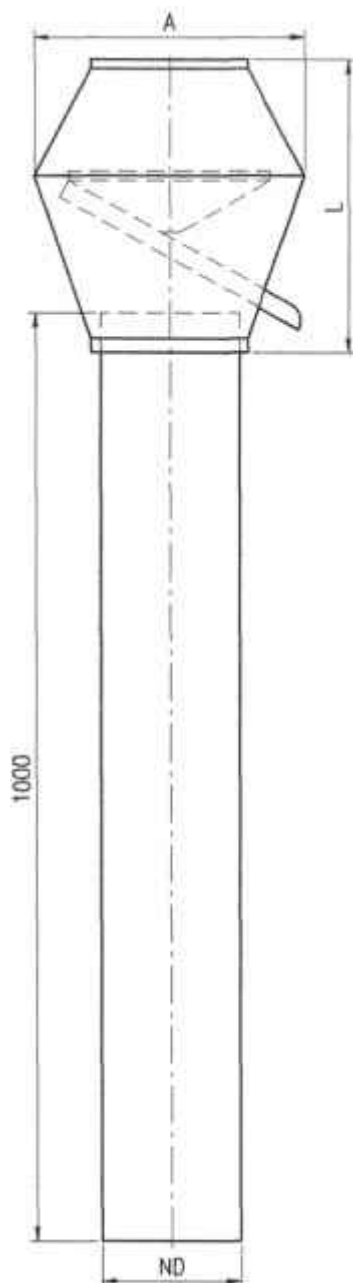

ND
100
125
140
150
160
175
190
200
250
300
350
400
450
500

REGENHUT

Typ: AR - Kurz



Preise nur auf Anfrage

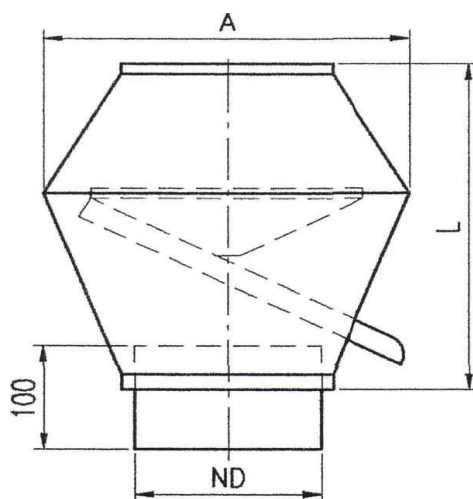

ND
100
125
140
150
160
175
190
200
250
300
350
400
450
500

REGENHUT

Typ: AT



Preise nur auf Anfrage

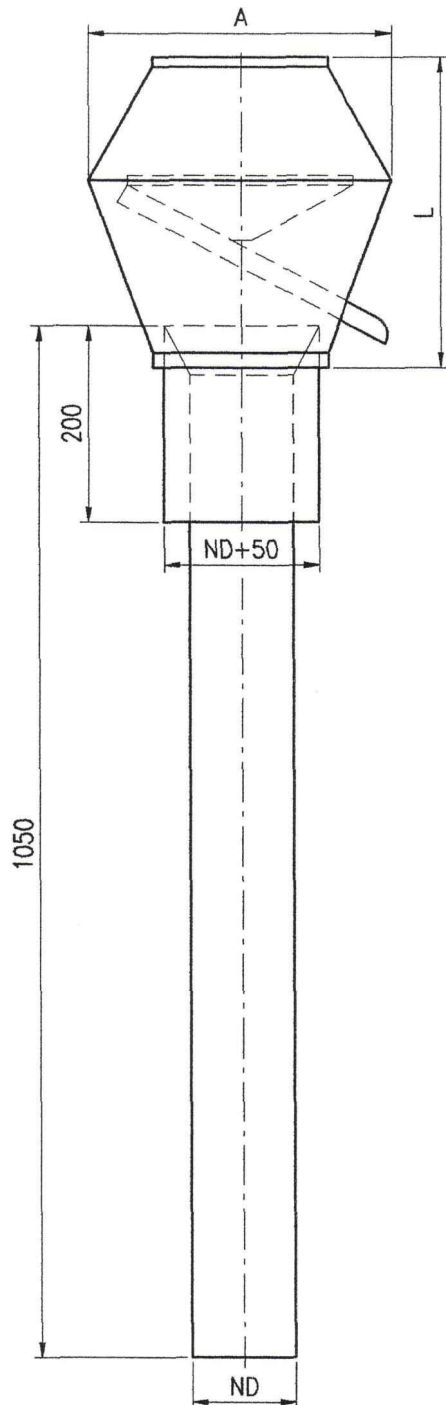

ND / (ND+50)
100 / 150
125 / 175
140 / 190
150 / 200
160 / 210
175 / 225
190 / 240
200 / 250
250 / 300
300 / 350
350 / 400
400 / 450
450 / 500
500 / 550

REGENHUT

Typ: ARI



Preise nur auf Anfrage

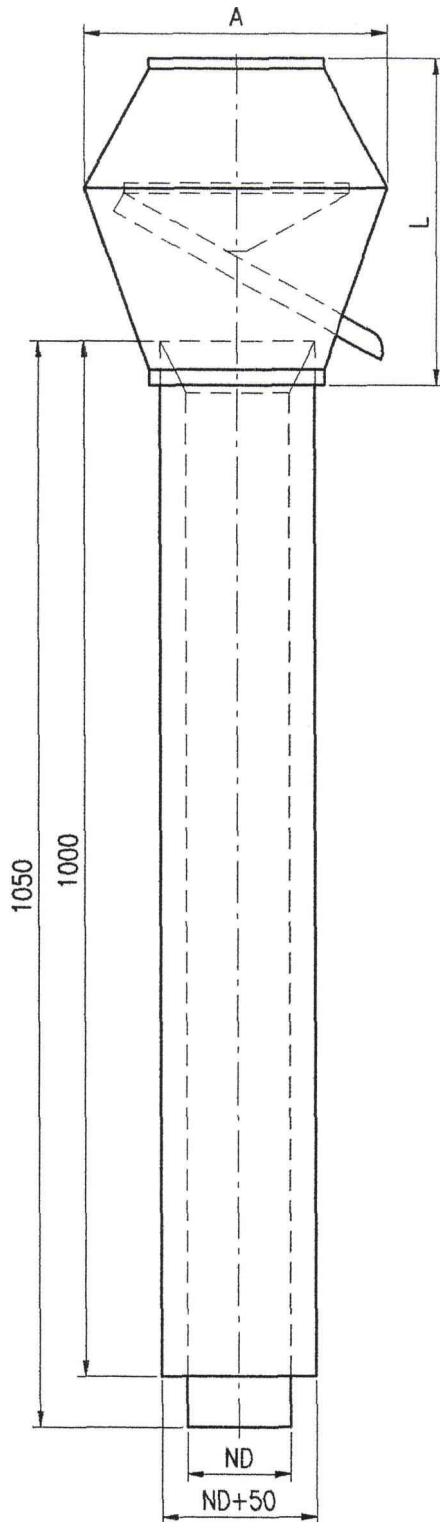

ND / (ND+50)
100 / 150
125 / 175
140 / 190
150 / 200
160 / 210
175 / 225
190 / 240
200 / 250
250 / 300
300 / 350
350 / 400
400 / 450
450 / 500
500 / 550

RE - ABLUFTREGENHUT



Preise nur auf Anfrage

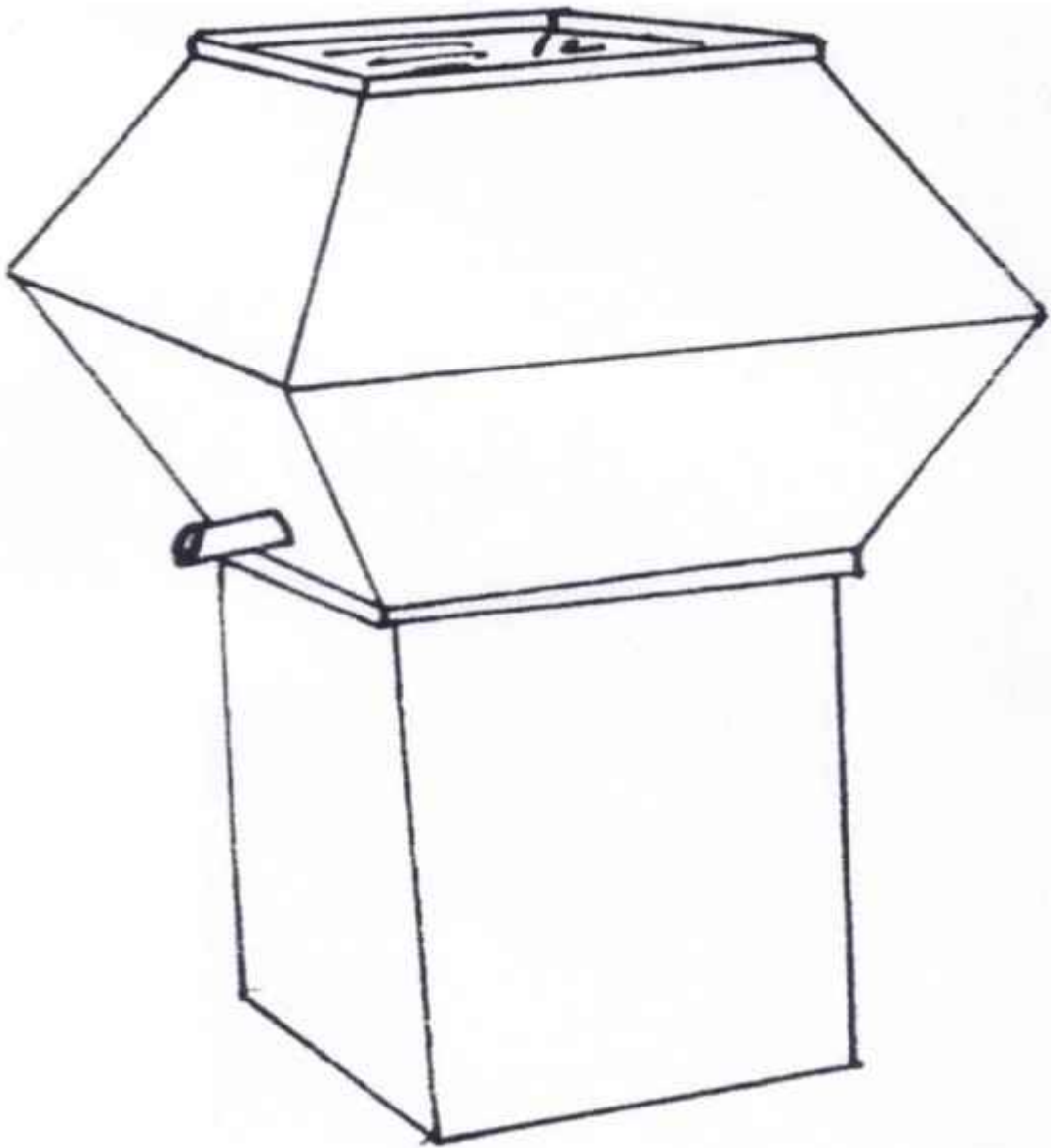

DACHHAUBE

HF 1 - Reihig



Preise nur auf Anfrage

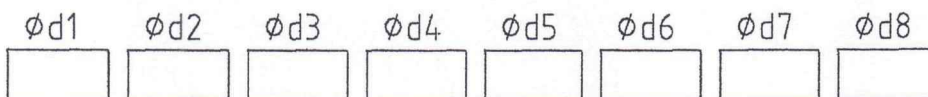
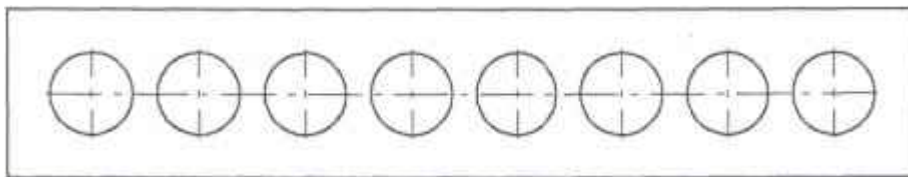
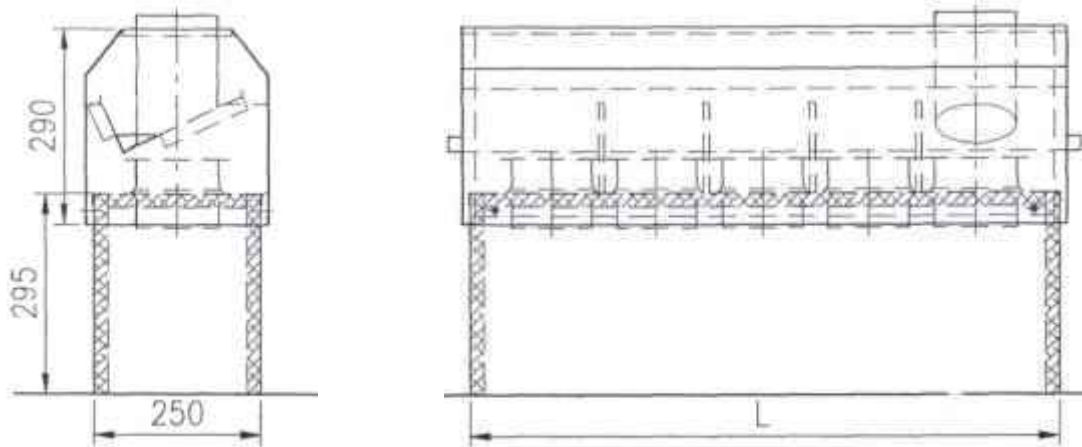

Masse können auch abweichen

Anzahl Stutzen	Breite x Länge
1	250 x 250
2	250 x 410
3	250 x 570
4	250 x 730
5	250 x 890
6	250 x 1050
7	250 x 1210
8	250 x 1370

DACHHAUBE

HF 2 - Reihig



Preise nur auf Anfrage

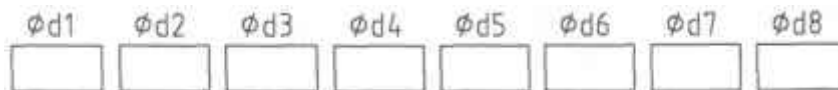
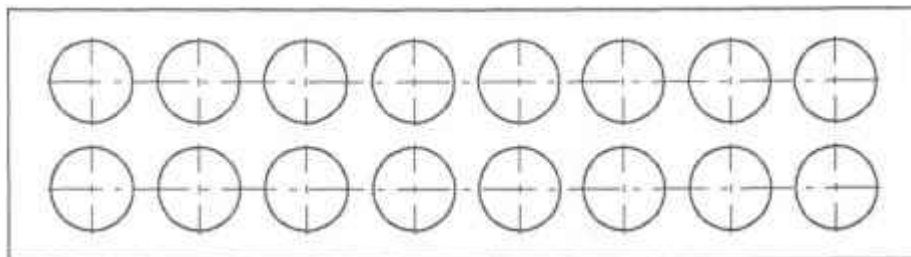
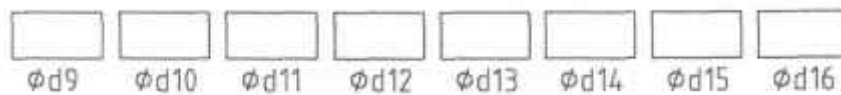
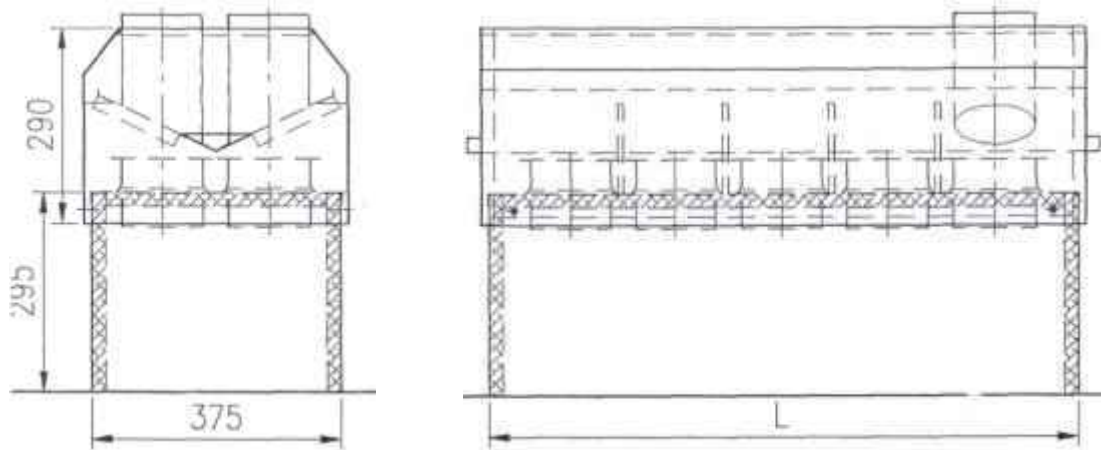

Anzahl Stützen in einer Reihe	Breite x Länge
1	375 x 250
2	375 x 410
3	375 x 570
4	375 x 730
5	375 x 890
6	375 x 1050
7	375 x 1210
8	375 x 1370